

**J 1154**  
0.148 Kg/m

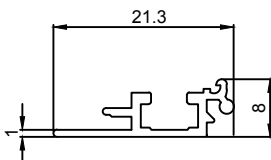

**J 1158**  
0.143 Kg/m

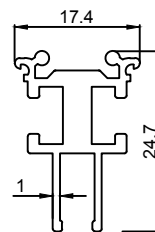

**J 1161**  
0.330 Kg/m

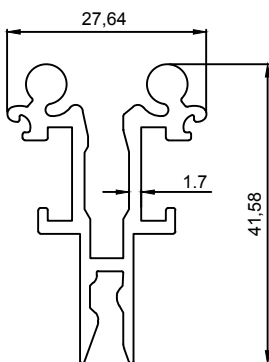

**J 1162**  
0.688 Kg/m

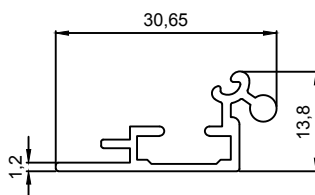

**J 1163**  
0.224 Kg/m

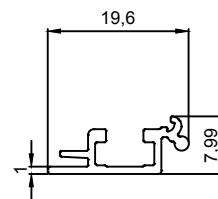

**J 1198**  
0,119 Kg/m

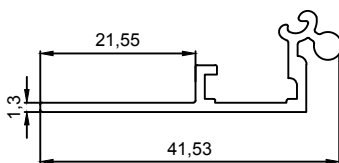

**J 1638**  
0,263 Kg/m

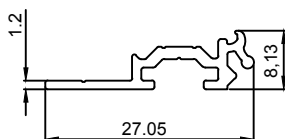

**J 19120**  
147.0 Kg/m

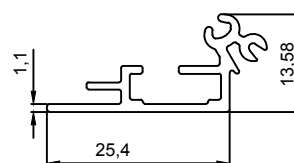

**J 19123**  
0.222 Kg/m

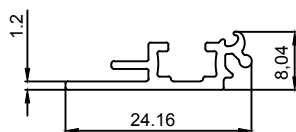

**J 19126**  
142.0 Kg/m

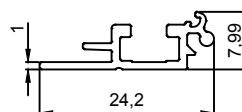

**J 1988**  
0,138 Kg/m

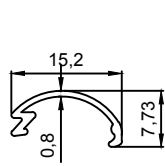

**J 1155**  
0.062 Kg/m

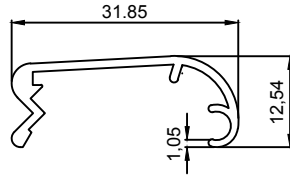

**J 1157**  
0.208 Kg/m

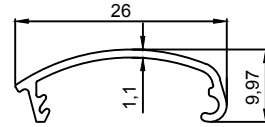

**J 1159**  
0.105 Kg/m

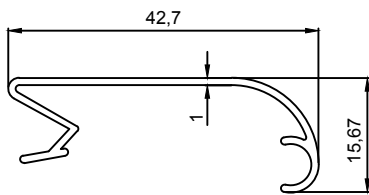

**J 1160**  
0.217 Kg/m

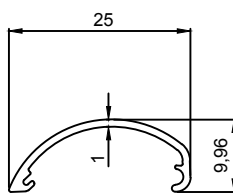

**J 1171**  
0,103 Kg/m

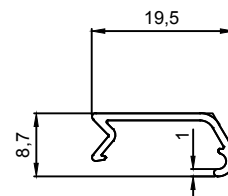

**J 1199**  
0,089 Kg/m

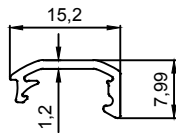

**J 1269**  
0,084 Kg/m

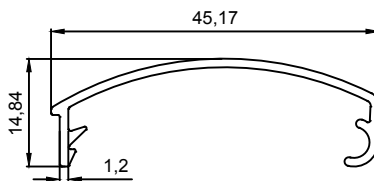

**J 1579**  
0.233 Kg/m

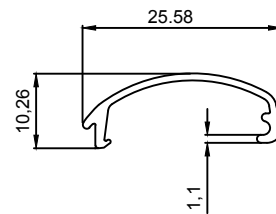

**J 19121**  
0.108 Kg/m

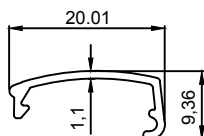

**J 19122**  
0.091 Kg/m

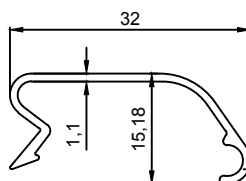

**J 19125**  
0.157 Kg/m

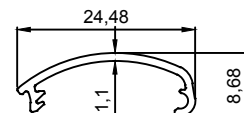

**J 1987**  
0,103 Kg/m

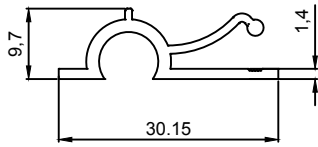

**J 1173**  
0,221 Kg/m

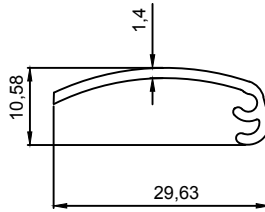

**J 1174**  
0,154 Kg/m

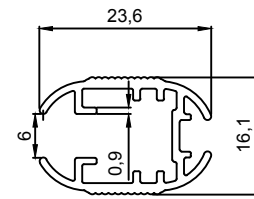

**J 1613**  
0.245 Kg/m

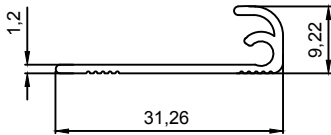

**J 1203**  
0,151 Kg/m

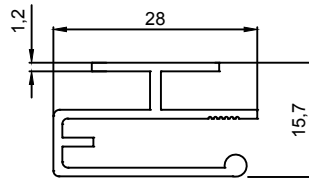

**J 1204**  
0,300 Kg/m

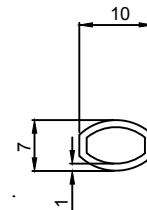

**J 1242**  
0,068 Kg/m

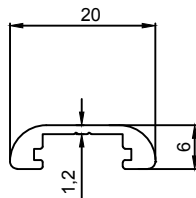

**J 1509**  
0,140 Kg/m

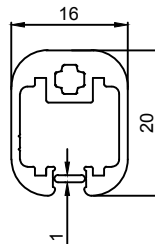

**J 1510**  
0,352 Kg/m

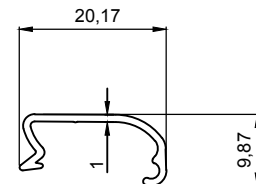

**J 1629**  
0,102 Kg/m

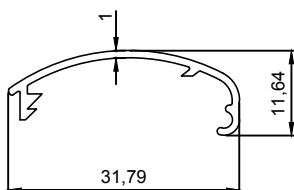

**J 1182**  
0,138 Kg/m

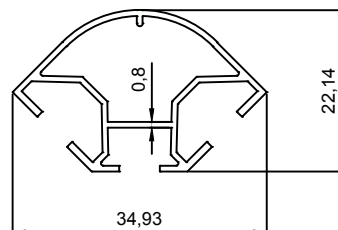

**J 1963**  
0,263 Kg/m

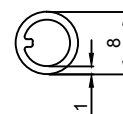

**J 19124**  
0.066 Kg/m

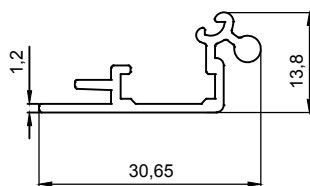

**J 1179**  
0,224 Kg/m

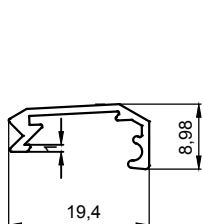

**J 1180**  
0,108 Kg/m

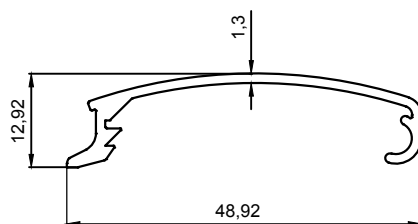

**J 1181**  
0,275 Kg/m

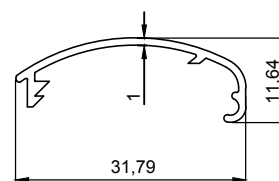

**J 1182**  
0,138 Kg/m

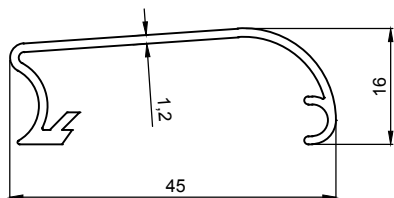

**J 1183**  
0,273 Kg/m

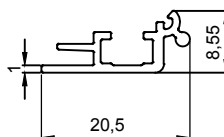

**J 1184**  
0,121 Kg/m

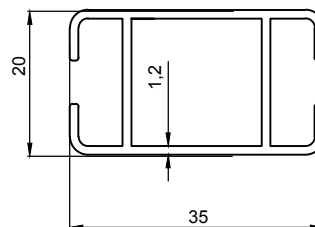

**J 1185**  
0,405 Kg/m

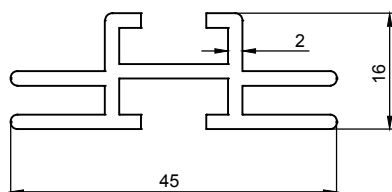

**J 1186**  
0,594 Kg/m

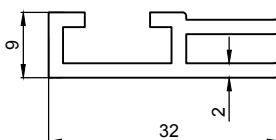

**J 1187**  
0,348 Kg/m

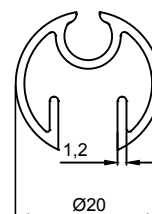

**J 1188**  
0,241 Kg/m

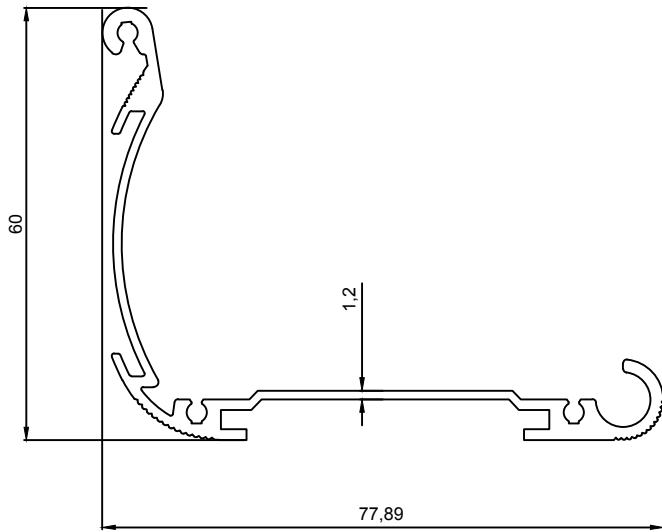

**J 1057**  
0,778 Kg/m

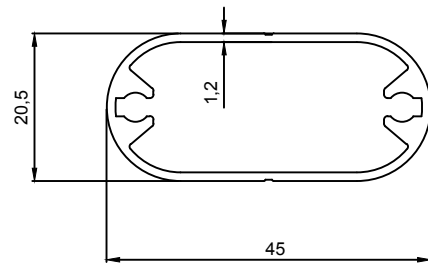

**J 1056**  
0,490 Kg/m

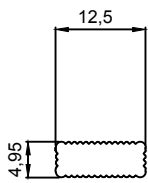

**J 1137**  
0,157 Kg/m

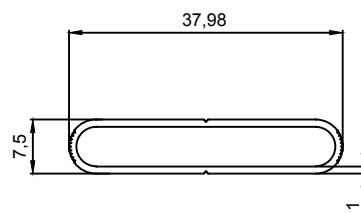

**J 1202**  
0,216 Kg/m

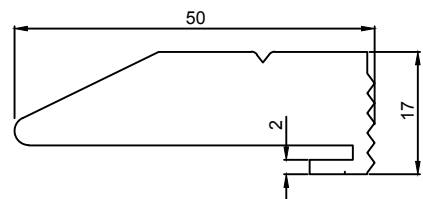

**J 1297**  
1,525 Kg/m

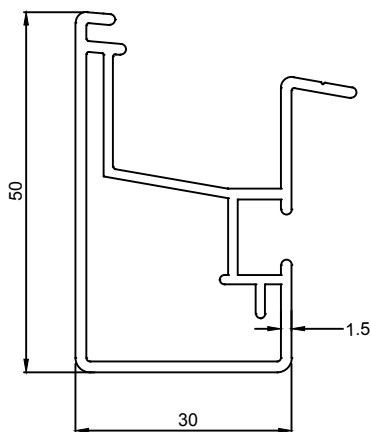

**J 1512**  
0,751 Kg/m

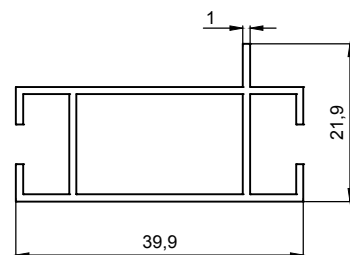

**J 1964**  
0,354 Kg/m